

SPECIFICATION
FOR
LCM+RTP Module

MODULE No:	KD070HDFIA018-RT
CUSTOMER:	

STARTEK	INITIAL	DATE
PREPARED BY		
CHECKED BY		
APPROVED BY		

CUSTOMER	INITIAL	DATE
APPROVED BY		

Revision History

Date	Rev. No.	Page	Summary
2018.08.23	V1.0	ALL	FIRST ISSUE

Contents

1.	Block Diagram	5
2.	Outline dimension	6
3.	Input terminal Pin Assignment	7
4.	LCD Optical Characteristics	9
4.1	Optical specification	9
5.	Electrical Characteristics	11
5.1	Absolute Maximum Rating	11
5.2	DC Electrical Characteristics	11
5.3	LED Backlight Characteristics	12
6.	MIPI AC Characteristic	14
6.1	LP Transmitter AC Specification	14
6.2	Turnaround Procedure	15
6.3	High speed transmission	16
6.4	High Speed Clock Transmission	17
6.5	High Speed Data Transmission in Bursts	18
7.	TP Feature	19
7.1	Conditions of use and storage	19
7.2	Electrical property	19
7.3	Mechanical property	20
7.4	Optical propertys	20
8.	LCD Module Out-Going Quality Level	21
8.1	VISUAL & FUNCTION INSPECTION STANDARD	21
8.1.1	Inspection conditions	21
8.1.2	Definition	21
8.1.3	Sampling Plan	22
8.1.4	Criteria (Visual)	23
9.	Reliability Test Result	28
10.	Cautions and Handling Precautions	29
10.1	Handling and Operating the Module	29
10.2	Storage and Transportation	29
11.	Packing	30

Part. No	KD070HDFIA018-RT	REV	V1.0	Page 3 of 30
	常备库存 Stock For Sale	长期供货 Long Time supply	支持小量 NO MOQ	品种齐全 In Full Range

*** Description**

This is a color active matrix TFT (Thin Film Transistor) LCD (liquid crystal display) that uses amorphous silicon TFT as a switching device. This module is composed of a Transmissive type TFT-LCD Panel, driver circuit, 4 wires resistance touch screen, back-light unit. The resolution of a 7.0 " TFT-LCD contains 1024x600 pixels, and can display up to 16.7M colors.

*** Features**

General Information Items	Specification	Unit	Note
	Main Panel		
Display area(AA)	154.21(H)*85.92 (V) (7.0inch)	mm	
Driver element	TFT active matrix	-	
Display colors	16.7M	colors	
Number of pixels	1024(RGB)*600	dots	
Pixel arrangement	RGB vertical stripe	-	
Pixel pitch	0.1506(H)*0.1432(V)	mm	
Viewing angle	Free	o'clock	
Controller IC	EK73217BCGA+EK79007AD	-	
LCM Interface	4Lane MIPI	-	
Display mode	Transmissive /Normally Black	-	
Operating temperature	-20~+70	°C	
Storage temperature	-30~+80	°C	

*** Mechanical Information**

Item		Min.	Typ.	Max.	Unit	Note
Module size	Horizontal(H)	-	165	-	mm	
	Vertical(V)	-	100	-	mm	
	Depth(D)	-	7.3	-	mm	
Weight		-	--	-	g	

Part. No	KD070HDFIA018-RT	REV	V1.0	Page 4 of 30
常备库存 Stock For Sale	长期供货 Long Time supply	支持小量 NO MOQ	品种齐全 In Full Range	

1. Block Diagram

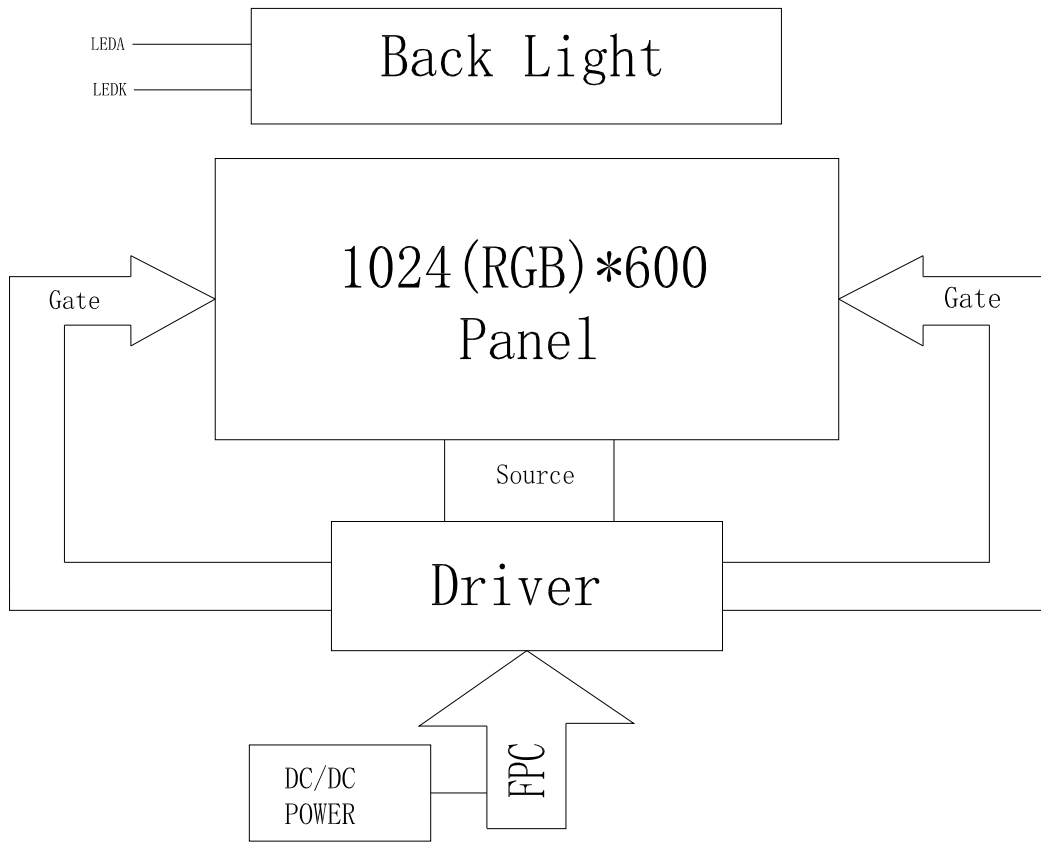

Part. No	KD070HDFIA018-RT	REV	V1.0	Page 5 of 30
常备库存 Stock For Sale	长期供货 Long Time supply	支持小量 NO MOQ	品种齐全 In Full Range	

2. Outline dimension

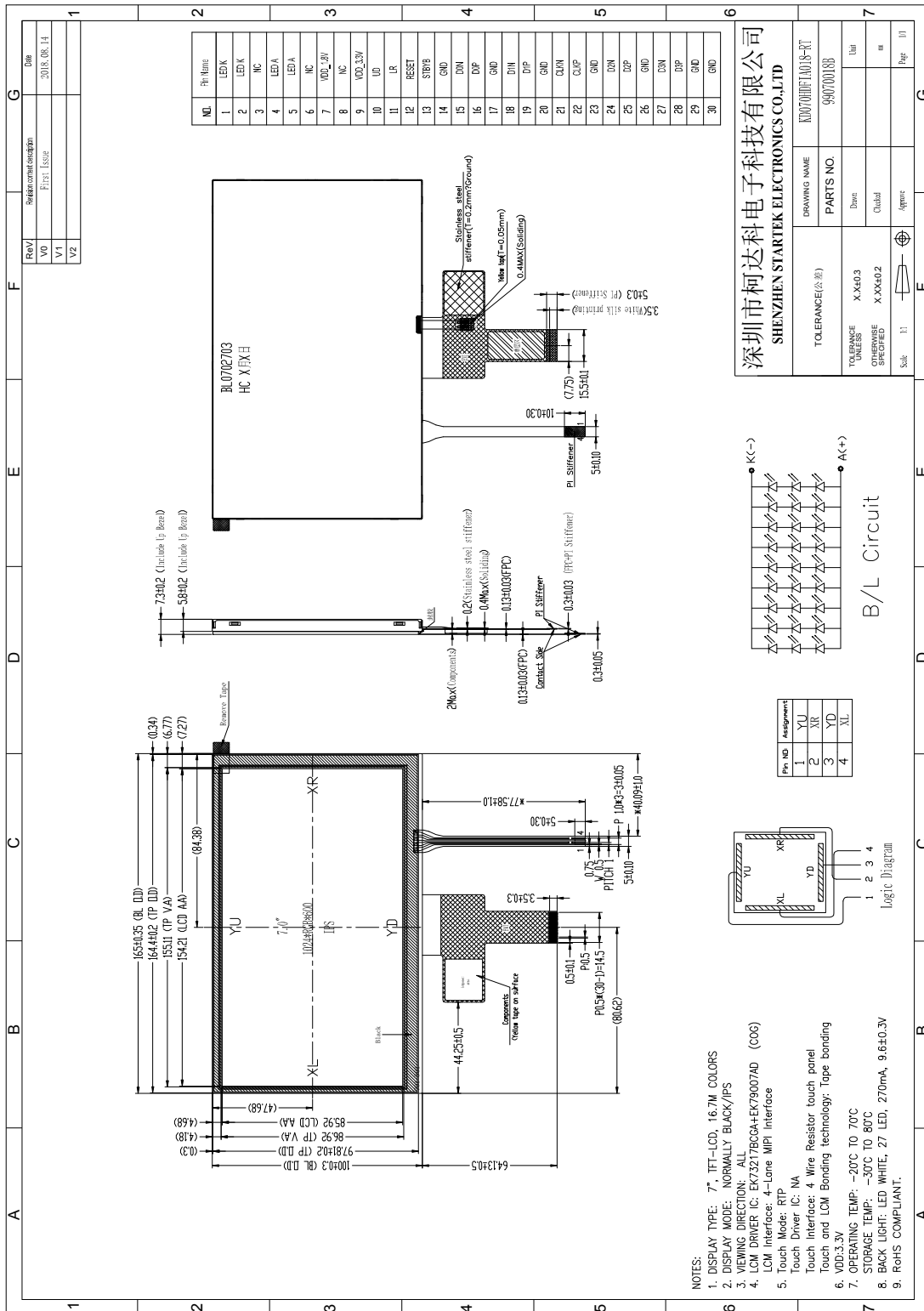

Part. No	KD070HDFIA018-RT	REV	V1.0	Page 6 of 30
常备库存 Stock For Sale	长期供货 Long Time supply	支持小量 NO MOQ	品种齐全 In Full Range	

3. Input terminal Pin Assignment

NO.	SYMBOL	DISCRIPTION	I/O
1	LEDK	LED Cathode	P
2	LEDK	LED Cathode	P
3	NC		
4	LEDA	LED Anode	P
5	LEDA	LED Anode	P
6	NC		
7	VDD_1.8V	Power supply for digital circuits	P
8	NC		
9	VDD_3.3V	Power supply for DC/DC convert circuit	P
10	UD	Vertical shift direction (gate output) selection(NOTE1)	I
11	LR	Horizontal shift direction (source output) selection(NOTE1)	I
12	RESET	Global reset pin. Active low to enter reset state.	I
13	STBYB	Standby mode, Normally pulled high STBYB = "1", normal operation STBYB = "0", timing controller, source driver will turn off, all o utput are High-Z.	I
14	GND	Ground	P
15	D0N	MIPI DSI differential data pair (Data lane 0)	I/O
16	D0P		
17	GND	Ground	P
18	D1N	MIPI DSI differential data pair (Data lane 1)	I/O
19	D1P		
20	GND	Ground	P
21	CLKN	MIPI DSI differential clock pair .	I
22	CLKP		
23	GND	Ground	P
24	D2N	MIPI DSI differential data pair (Data lane 2)	I/O
25	D2P		
26	GND	Ground	P
27	D3N	MIPI DSI differential data pair (Data lane 3)	I/O

Part. No	KD070HDFIA018-RT	REV	V1.0	Page 7 of 30
常备库存 Stock For Sale	长期供货 Long Time supply	支持小量 NO MOQ	品种齐全 In Full Range	

28	D3P	MIPI DSI differential data pair (Data lane 3)	
29	GND	Ground	P
30	GND	Ground	P

Note1: When L/R="0", set right to left scan direction.
 When L/R="1", set left to right scan direction.
 When U/D="0", set top to bottom scan direction.
 When U/D="1", set bottom to top scan direction.

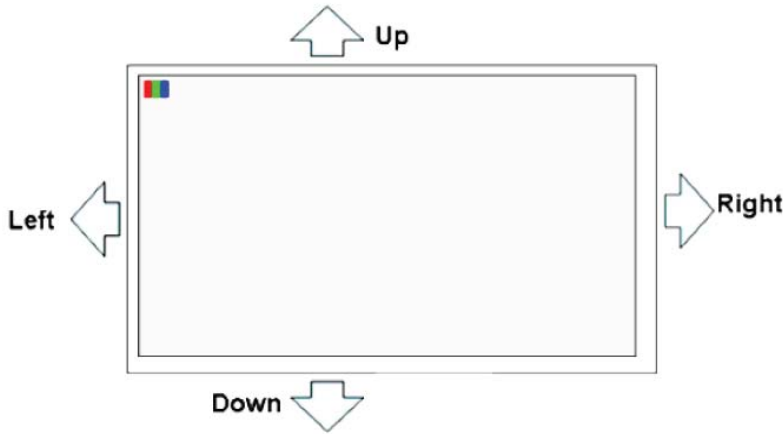

4. LCD Optical Characteristics

4.1 Optical specification

Item	Symbol	Condition	Min.	Typ.	Max.	Unit.	Note
Contrast Ratio	CR	$\Theta=0$	600	800	--		Note 2
Response time	Rising	Normal viewing angle	--	25	40	msec	Note 5
	Falling						
Uniformity	S(%)		--	50	--	%	Note 3
Color Filter Chromacicity	White	W_X	$\Theta = 0^\circ$	0.2668	0.3068	0.3468	Note 4 C light
		W_Y		0.2984	0.3384	0.3784	
	Red	R_X		0.5758	0.6158	0.6558	
		R_Y		0.2915	0.3315	0.3715	
	Green	G_X		0.2907	0.3307	0.3707	
		G_Y		0.5345	0.5745	0.6145	
	Blue	B_X		0.1066	0.1466	0.1866	
		B_Y		0.0738	0.1138	0.1538	
Viewing angle	Hor.	Θ_L	CR>10	--	85	--	Note 1
		Θ_R		--	85	--	
	Ver.	Θ_U		--	85	--	
		Θ_D		--	85	--	
Option View Direction	FREE						

- Notes : 1. Viewing angle is the angle at which the contrast ratio is greater than 10. The viewing angles are determined for the horizontal or 3, 9 o'clock direction and the vertical or 6, 12 o'clock direction with respect to the optical axis which is normal to the LCD surface (see FIGURE 1).
2. Contrast measurements shall be made at viewing angle of $\Theta = 0$ and at the center of the LCD surface. Luminance shall be measured with all pixels in the view field set first to white, then to the dark (black) state . (see FIGURE 1) Luminance Contrast Ratio (CR) is defined mathematically.

$$CR = \frac{\text{Luminance when displaying a white raster}}{\text{Luminance when displaying a black raster}}$$

3. Transmittance is the Value with Polarizer
4. The color chromaticity coordinates specified in Table 5 shall be calculated from the spectral data measured with all pixels first in red, green, blue and white. Measurements shall be made at the center of the panel.
5. The electro-optical response time measurements shall be made as FIGURE 3 by switching the "data" input signal ON and OFF. The times needed for the luminance to change from 10% to 90% is T_r , and 90% to 10% is T_d .

Part. No	KD070HDFIA018-RT	REV	V1.0	Page 10 of 30
	常备库存 Stock For Sale	长期供货 Long Time supply	支持小量 NO MOQ	品种齐全 In Full Range

5. Electrical Characteristics

5.1 Absolute Maximum Rating

Characteristics	Symbol	Min.	Max.	Unit	Note
Power supply for digital circuits	VDD_1.8V	-0.3	2.0	V	Note1
Power supply for DC/DC convert circuit	VDD_3.3V	-0.3	6.0	V	Note1
Operating temperature	T _{OP}	-20	+70	°C	
Storage temperature	T _{ST}	-30	+80	°C	

NOTE1: If the absolute maximum rating of even is one of the above parameters is exceeded even momentarily, the quality of the product may be degraded. Absolute maximum ratings, therefore, specify the values exceeding which the product may be physically damaged. Be sure to use the product within the range of the absolute maximum ratings.

5.2 DC Electrical Characteristics

Characteristics	Symbol	Min.	Typ.	Max.	Unit	Note
Power supply for digital circuits	VDD_1.8V	1.71	1.8	1.89	V	
Power supply for DC/DC convert circuit	VDD_3.3V	2.7	3.3	5.8	V	
Normal mode Current	IDD_1.8V	--	0.05	--	mA	
Normal mode Current	IDD_3.3V	--	200	--	mA	
Low Level input voltage	V _{IH}	0.7*VDD_1.8V	--	VDD_1.8V	V	
	V _{IL}	0	--	0.3*VDD_1.8V	V	

Part. No	KD070HDFIA018-RT	REV	V1.0	Page 11 of 30
常备库存 Stock For Sale	长期供货 Long Time supply	支持小量 NO MOQ	品种齐全 In Full Range	

High Level output voltage	V _{OH}	VDD_1.8 V-0.4	--	VDD_1.8 V	V	
	V _{OL}	0	--	0.4	V	

5.3 LED Backlight Characteristics

The back-light system is edge-lighting type with 27 chips LED

Item	Symbol	Min.	Typ.	Max.	Unit	Note
Forward Current	I _F	180	270	--	mA	
Forward Voltage	V _F	--	9.6	--	V	
LCM Luminance (I _F =180mA)	LV	310	360	--	cd/m ²	Note3
LCM Luminance (I _F =270mA)	LV	430	480	--	cd/m ²	Note3
LED life time	Hr	--	50000	--	Hour	Note1,2
Uniformity	Avg	80	--	--	%	Note3

Note1: LED life time (Hr) can be defined as the time in which it continues to operate under the condition:

T_a=25±3 °C, typical IL value indicated in the above table until the brightness becomes less than 50%.

Note 2: The “LED life time” is defined as the module brightness decrease to 50% original brightness at

T_a=25°C and I_L=270mA. The LED lifetime could be decreased if operating I_L is larger than 270mA. The constant current driving method is suggested.

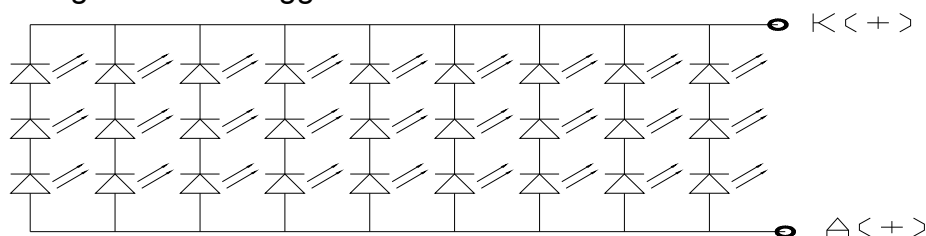

B/L Circuit

Part. No	KD070HDFIA018-RT	REV	V1.0	Page 12 of 30
常备库存 Stock For Sale	长期供货 Long Time supply	支持小量 NO MOQ	品种齐全 In Full Range	

Note (3) Luminance Uniformity of these 9 points is defined as below:

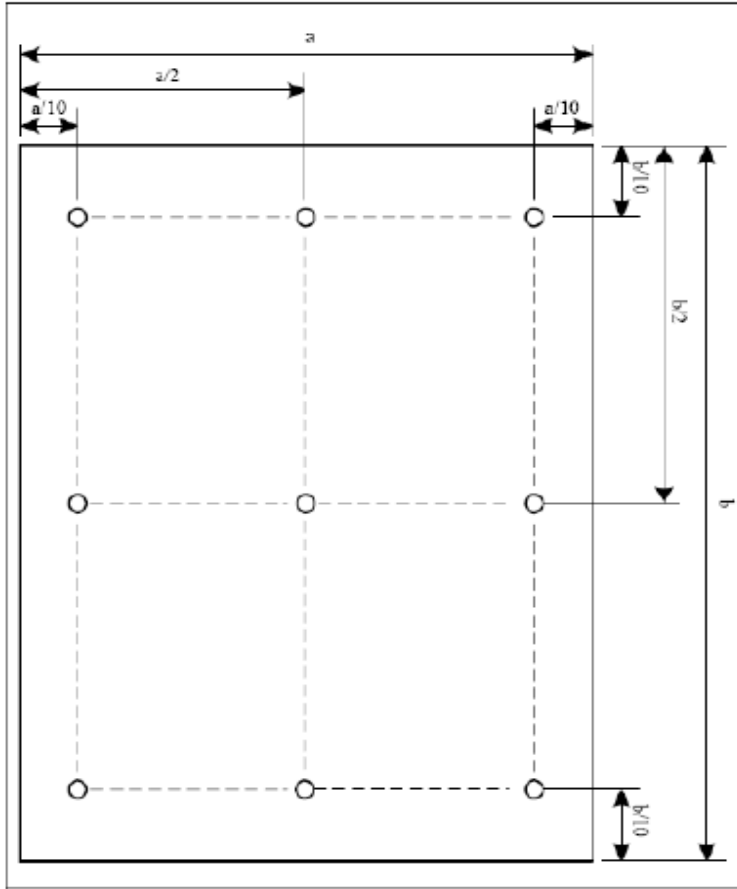

$$\text{Uniformity} = \frac{\text{minimum luminance in 9 points (1-9)}}{\text{maximum luminance in 9 points (1-9)}}$$

$$\text{Luminance} = \frac{\text{Total Luminance of 9 points}}{9}$$

Part. No	KD070HDFIA018-RT	REV	V1.0	Page 13 of 30
常备库存 Stock For Sale	长期供货 Long Time supply	支持小量 NO MOQ	品种齐全 In Full Range	

6. MIPI AC Characteristic

6.1 LP Transmitter AC Specification

Parameter	Symbol	Min	Typ	Max	Units	Notes
15%~85% rising time and falling time	T_{RLP} / T_{FLP}	-	-	25	ns	-
30%~85% rising time and falling time	T_{REOT}	-	-	35	ns	-
Pulse width of LP exclusive-OR clock	First LP EXOR clock pulse after STOP state or Last pulse before stop state	40	-	-	ns	-
	All other pulses	20	-	-	ns	-
Period of the LP EXOR clock	$T_{LP-PER-TX}$	90	-	-	mV/ns	-
Slew Rate @CLOAD =0pF	$\delta V / \delta t_{SR}$	30	-	500	mV/ns	-
Slew Rate @CLOAD =5pF		30	-	200	mV/ns	-
Slew Rate @CLOAD =20pF		30	-	150	mV/ns	-
Slew Rate @CLOAD =70pF		30	-	100	mV/ns	-
Load Capacitance	T_{RLP}	-	-	70	pF	-

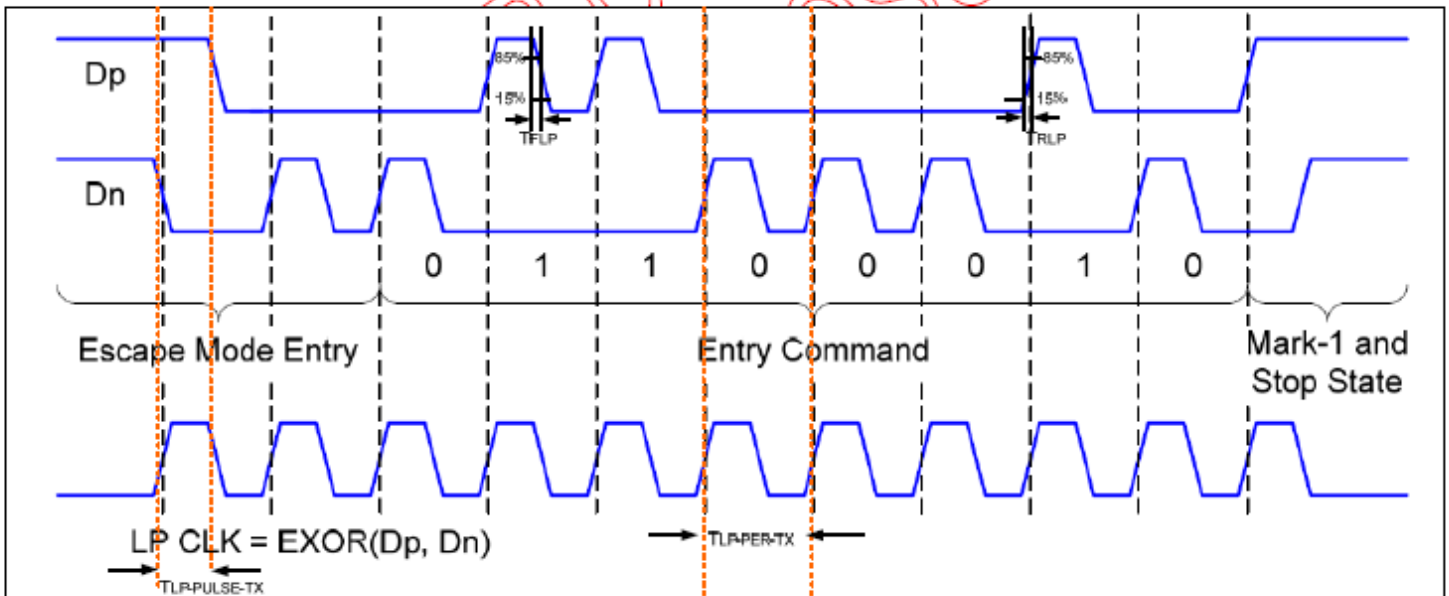

Part. No	KD070HDFIA018-RT	REV	V1.0	Page 14 of 30
常备库存 Stock For Sale	长期供货 Long Time supply	支持小量 NO MOQ	品种齐全 In Full Range	



6.2 Turnaround Procedure

Turnaround Procedure Operation Timing Parameters

Parameter	Symbol	Min	Typ	Max	Units
Length of any Low-Power state period: Master side	T_{LPX}	50	-	75	ns
Length of any Low-Power state period: Slave side	T_{LPX}	50	55.56	58.34	ns
Ratio of T_{LPX} (Master)/ T_{LPX} (Slave) between Master and Slave side	Ratio T_{LPX}	2/3	-	3/2	
Time-out before new TX side start driving	$T_{TA-Sure}$	T_{LPX}	-	$2T_{LPX}$	ns
Time to drive LP-00 by new TX	T_{TA-GET}	-	$5T_{LPX}$	-	ns
Time to drive LP-00 after Turnaround Request	T_{TA-GO}	-	$4T_{LPX}$	-	ns

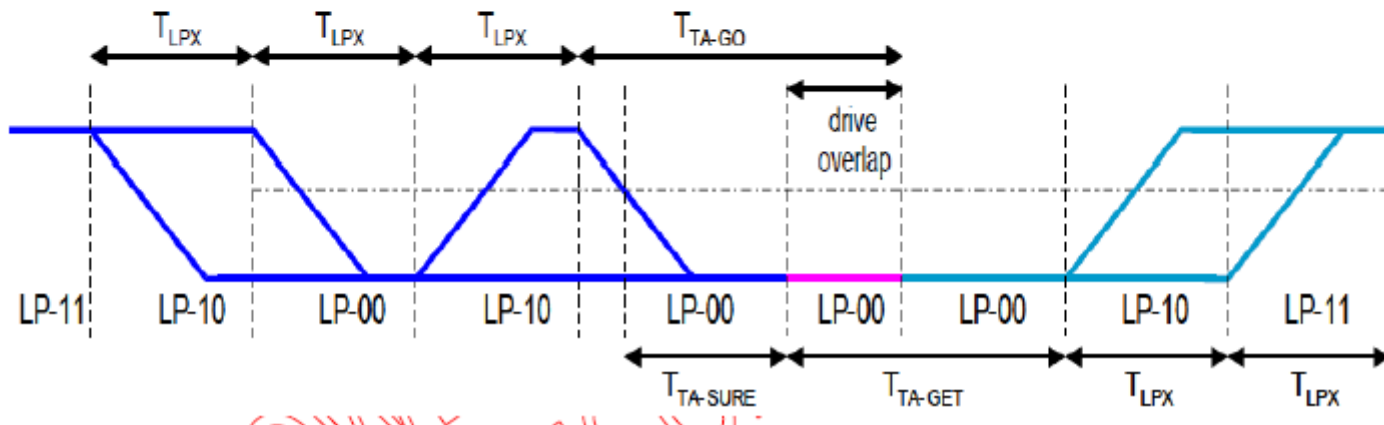
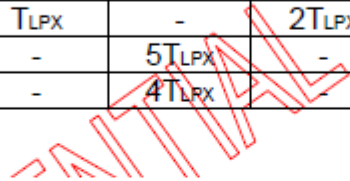

6.3 High speed transmission

Parameter	Symbol	Min	Typ	Max	Units
UI instantaneous	U_{INST}	2	-	12.5	ns
Data to Clock Skew(measured at transmitter)	$T_{SKEW(TX)}$	-0.15	-	0.15	U_{INST}
Data to Clock Setup time(measured at receiver)	$T_{SETUP(RX)}$	0.15	-	-	U_{INST}
Data to Clock Hold time(measured at receiver)	$T_{HOLD(RX)}$	0.15	-	-	U_{INST}
20%~80% rise time and fall time	T_R, T_F	150	-	-	ps
		-	-	0.3	U_{INST}

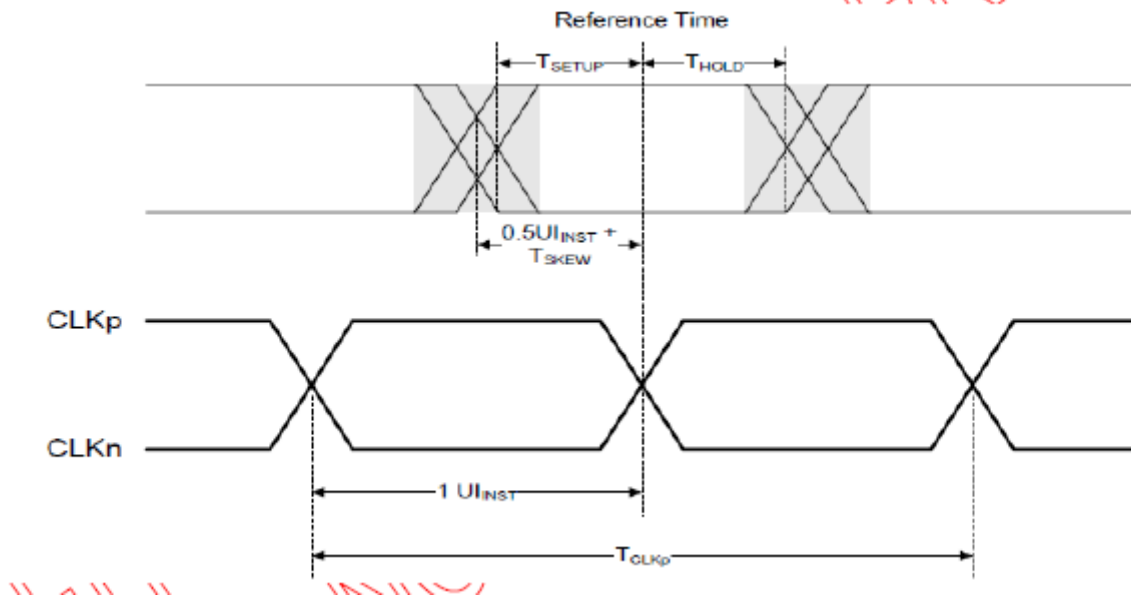

6.4 High Speed Clock Transmission

Parameter	Symbol	Min	Typ	Max	Units
Time that the transmitter shall continue sending HS clock after the last associated Data Lane has transitioned to LP mode	TCLK-POST	60+52UI	-	-	ns
Detection time that the clock has stopped toggling	TCLK-MISS	-	-	60	ns
Time to drive LP-00 to prepare for HS clock transmission	TCLK-PREPARE	38	-	95	ns
Minimum lead HS-0 drive period before starting clock	TCLK-PREPARE + TCLK-ZERO	300	-	-	ns
Time to enable Clock Lane receiver line termination measured from when Dn cross $V_{IL,MAX}$	THS-TERM-EN	-	-	38	ns
Minimum time that the HS clock must be prior to any associated data lane beginning the transmission from LP to HS mode	TCLK-PRE	8	-	-	UI
Time to drive HS differential state after last payload clock bit of a HS transmission burst	TCLK-TRAIL	60	-	-	ns

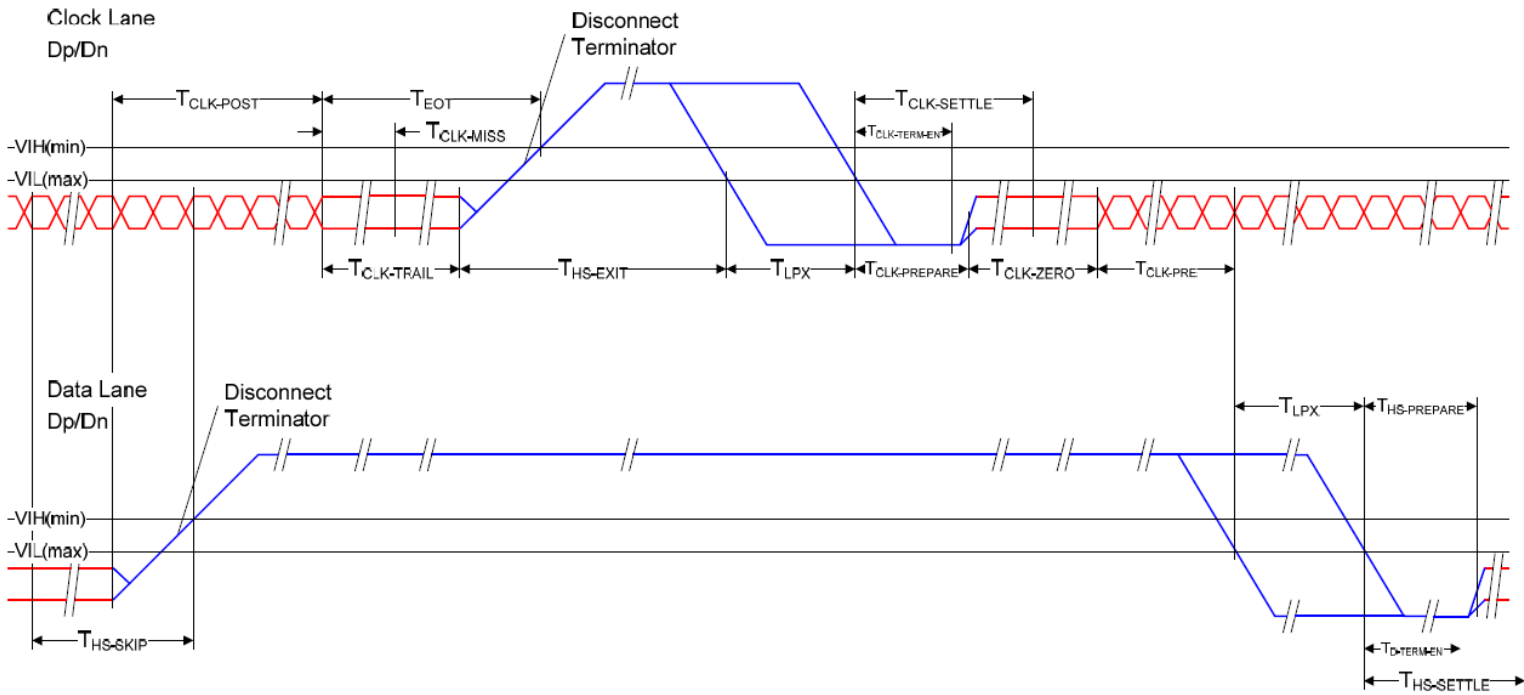

6.5 High Speed Data Transmission in Bursts

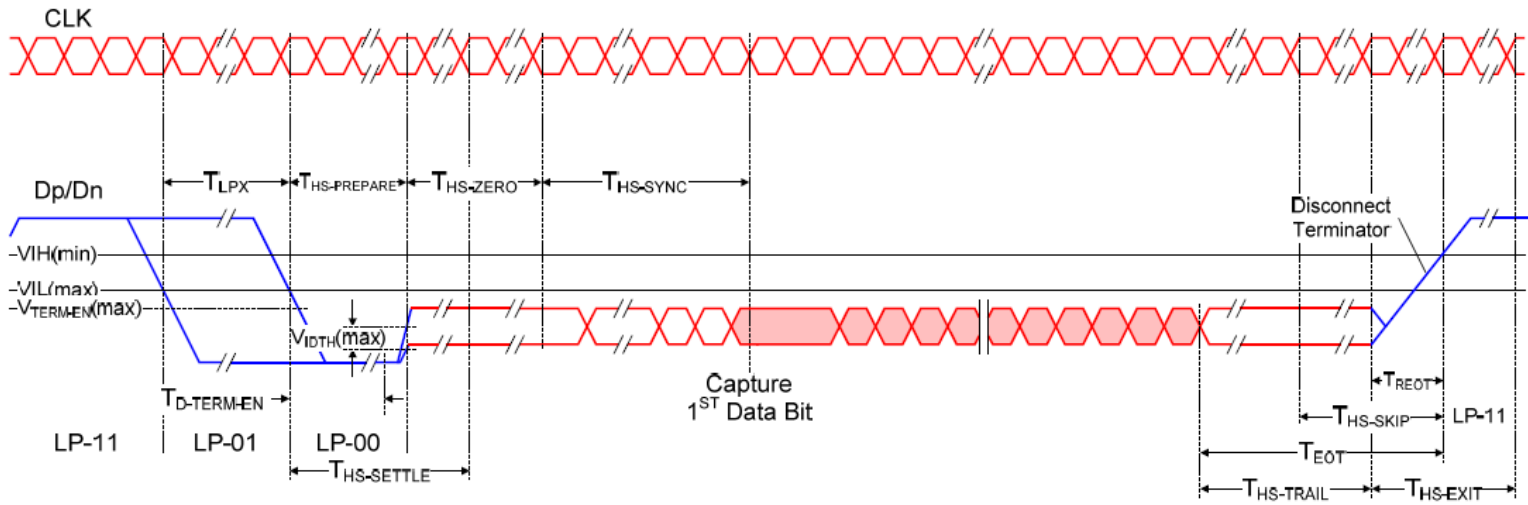

Part. No	KD070HDFIA018-RT	REV	V1.0	Page 18 of 30
常备库存 Stock For Sale	长期供货 Long Time supply	支持小量 NO MOQ	品种齐全 In Full Range	

7. TP Feature

7.1 Conditions of use and storage

Item	Value(condition)	Note
Temperature range upon operation	Humidity: 20%~90% non dew, condensation -20°C~70°C	In a simple substance
Temperature range upon storage	Humidity: 20%~90% non dew, condensation -30°C~80°C	In a simple substance

7.2 Electrical property

Item	Value	Note
Maximum voltage	DC5V	
Resistance between terminals	X direction[Film side]:200-600Ω Y direction [Glass side]:300-900Ω	
Insulation resistance	DC 25V 20MΩor above	Connect X + ~X- and Y+ ~Y-, apply 25VDC Between X and Y for perform measurements
Chattering	10 msec or below	
Rating	Voltage is DC 5V	

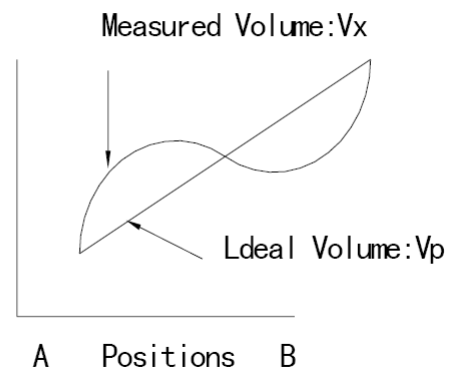
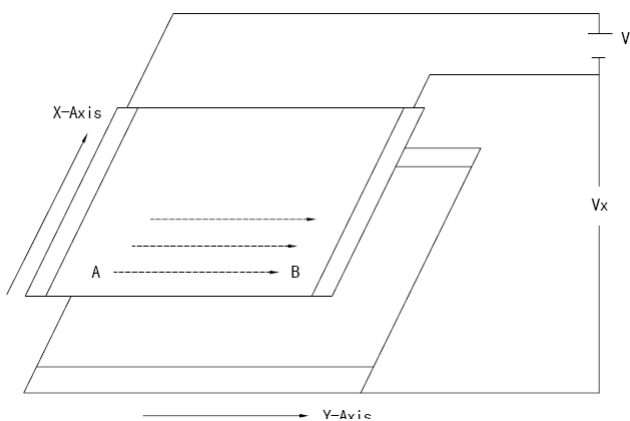

Part. No	KD070HDFIA018-RT	REV	V1.0	Page 19 of 30
常备库存 Stock For Sale	长期供货 Long Time supply	支持小量 NO MOQ	品种齐全 In Full Range	

7.3 Mechanical property

Item	Performance		Note
Input method	Used of an exclusive pen or finger		
Load upon operation	Exclusive pen	60-100g or below	Operation and measurement with a pen must be carried out under the following tip condition s: Stylus pen material : POM(ployacetal) . Tip : Diameter 3.0mm, SR 0.8 mm
	Finger	60-100g or below	Operations and measurement methods simulate d for a finger must be carried out under the fo llowing tip conditions. Material :Silicon rubber (Hardness : 30°Hs) Tip : Diameter 12.0 mm, SR 12.5mm
Surface hardness	Pencil hardness : 3H or above		It complies with the way of test method JIS K5400.

7.4 Optical property

Item	Performance	Note
Total light transmittance	80% or above	JIS K7105
Haze	5% or below	JIS K7136
Film specification	Polished type with hard coated surface	

8. LCD Module Out-Going Quality Level

8.1 VISUAL & FUNCTION INSPECTION STANDARD

8.1.1 Inspection conditions

Inspection performed under the following conditions is recommended.

Temperature : 25±5℃

Humidity : 65%±10%RH

Viewing Angle : Normal viewing Angle.

Illumination: Single fluorescent lamp (300 to 700Lux)

Viewing distance:30-50cm

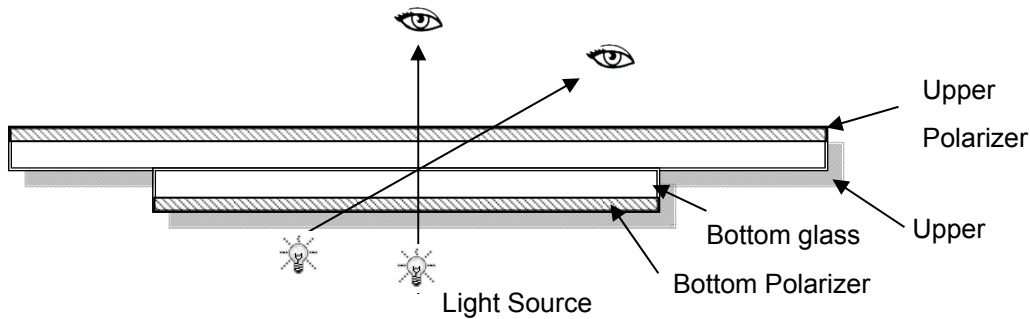

8.1.2 Definition

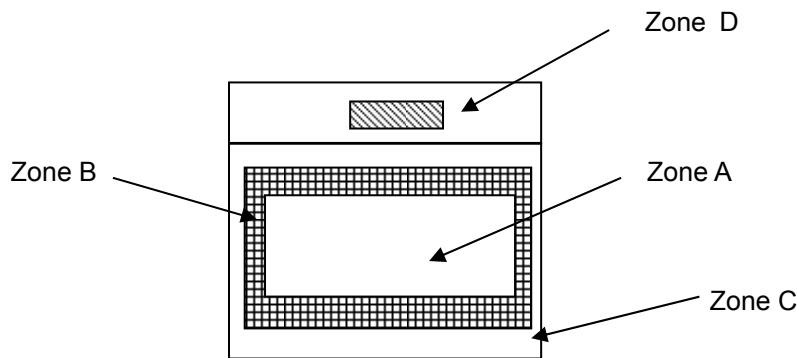

Zone A : Effective Viewing Area(Character or Digit can be seen)

Zone B : Viewing Area except Zone A

Zone C : Outside (Zone A+Zone B) which can not be seen after assembly by customer .)

Zone D : IC Bonding Area

Note:As a general rule ,visual defects in Zone C can be ignored when it doesn't effect product function or appearance after assembly by customer

Part. No	KD070HDFIA018-RT	REV	V1.0	Page 21 of 30
常备库存 Stock For Sale	长期供货 Long Time supply		支持小量 NO MOQ	品种齐全 In Full Range

8.1.3 Sampling Plan

According to GB/T 2828.1-2003 ; , normal inspection, Class II

AQL:

Major defect	Minor defect
0.65	1.5

LCD: Liquid Crystal Display , TP: Touch Panel , LCM: Liquid Crystal Module

No	Items to be inspected	Criteria	Classification of defects
1	Functional defects	1) No display, Open or miss line 2) Display abnormally, Short 3) Backlight no lighting, abnormal lighting. 4) TP no function	Major
2	Missing	Missing component	
3	Outline dimension	Overall outline dimension beyond the drawing is not allowed	
4	Color tone	Color unevenness, refer to limited sample	Minor
5	Spot Line defect	Light dot, Dim spot, Polarizer Bubble ; Polarizer accidented spot.	
6	Soldering appearance	Good soldering , Peeling off is not allowed.	
7	LCD/Polarizer/TP	Black/White spot/line, scratch, crack, etc.	

8.1.4 Criteria (Visual)

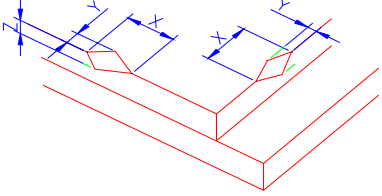
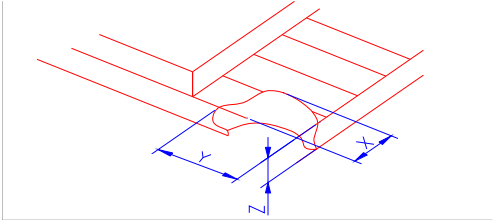
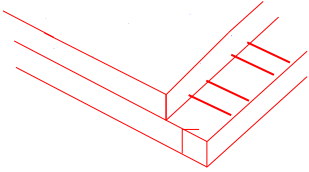
Number	Items	Criteria(mm)						
1.0 LCD Crack/Broken NOTE: X: Length Y: Width Z: Height L: Length of ITO, T: Height of LCD	(1) The edge of LCD broken	 <table border="1" data-bbox="756 667 1455 815"> <thead> <tr> <th>X</th> <th>Y</th> <th>Z</th> </tr> </thead> <tbody> <tr> <td>≤3.0mm</td> <td><Inner border line of the seal</td> <td>≤T</td> </tr> </tbody> </table>	X	Y	Z	≤3.0mm	<Inner border line of the seal	≤T
X	Y	Z						
≤3.0mm	<Inner border line of the seal	≤T						
	(2)LCD corner broken	 <table border="1" data-bbox="836 1124 1375 1223"> <thead> <tr> <th>X</th> <th>Y</th> <th>Z</th> </tr> </thead> <tbody> <tr> <td>≤3.0mm</td> <td>≤L</td> <td>≤T</td> </tr> </tbody> </table>	X	Y	Z	≤3.0mm	≤L	≤T
X	Y	Z						
≤3.0mm	≤L	≤T						
	(3) LCD crack	 <p style="text-align: center;">Crack Not allowed</p>						



2.0

Spot defect

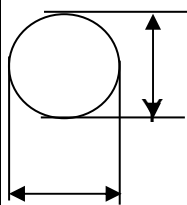

X

$$\Phi = (X+Y)/2$$

① light dot (LCD/TP/Polarizer black/white spot , light dot, pinhole, dent, stain)

Zone Size (mm)	Acceptable Qty		
	A	B	C
$\Phi \leq 0.10$	Ignore		
$0.10 < \Phi \leq 0.25$	4(distance $\geq 10\text{mm}$)		
$0.25 < \Phi \leq 0.35$	3		
$\Phi > 0.4$	0		

② Dim spot (LCD/TP/Polarizer dim dot, light leakage, dark spot)

Zone Size (mm)	Acceptable Qty		
	A	B	C
$\Phi \leq 0.1$	Ignore		
$0.10 < \Phi \leq 0.25$	4(distance $\geq 10\text{mm}$)		
$0.25 < \Phi \leq 0.35$	3		
$\Phi > 0.4$	0		

③ Polarizer accidented spot

Zone Size (mm)	Acceptable Qty		
	A	B	C
$\Phi \leq 0.2$	Ignore		
$0.3 < \Phi \leq 0.5$	3(distance $\geq 10\text{mm}$)		
$\Phi > 0.5$	1		

④ Pixel bad points (light dot, Dim dot, color dot)



Zone Size (mm)	Acceptable Qty		
	A	B	C
$\Phi \leq 0.15$	Ignore		
$0.2 < \Phi \leq 0.3$	2(distance $\geq 10\text{mm}$)		
$\Phi > 0.4$	1		

⑤ Polarizer Bubble

Zone Size (mm)	Acceptable Qty		
	A	B	C
$\Phi \leq 0.2$	Ignore		
$0.3 < \Phi \leq 0.4$	4(distance $\geq 10\text{mm}$)		
$0.4 < \Phi \leq 0.5$	3		
$\Phi > 0.5$	1		

3.0	Line defect (LCD/TP /Polarizer backlight black/white line, scratch, stain)	Width(mm)	Length(m m)	Acceptable Qty		
				A	B	C
		$\Phi \leq 0.05$	Ignore	Ignore		
		$0.05 < W \leq 0.06$	$L \leq 5.0$	$N \leq 3$		
		$0.07 < W \leq 0.08$	$L \leq 4.0$	$N \leq 2$		
		$0.08 < W$	Define as spot defect			
4.0	Electronic Comp onents SMT	Not allow missing parts, solderless connection, cold solder joint, mis match, The positive and negative polarity opposite				
5.0	Display color& B rightness	1. Color: Measuring the color coordinates, The measurement standar d according to the datasheet or samples. 2. Brightness: Measuring the brightness of White screen, The measu rement standard according to the datasheet or Samples.				
6.0	LCD Mura	By 5% ND filter invisible.				

7.0	RTP Related	TP film bubble/ accidentec d spot	Size Φ (mm)	Acceptable Qty			
				A	B	C	
			$\Phi \leq 0.1$	Ignore			
			$0.1 < \Phi \leq 0.25$	4 (distance ≥ 10 mm)			
			$0.25 < \Phi \leq 0.35$	3			
						$\Phi > 0.4$	1
		TP film scratch	Width(mm)	Length(mm)	Acceptable Qty		
					A	B	C
			$\Phi \leq 0.05$	Ignore	Ignore		
			$0.05 < W \leq 0.06$	$L \leq 5.0$	$N \leq 3$		
$0.07 < W \leq 0.08$	$L \leq 4.0$		$N \leq 2$				
		$0.08 < W$	Define as spot defect				

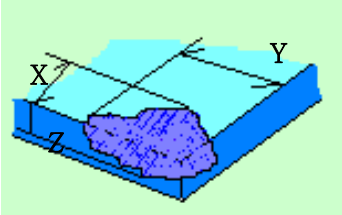
		Assembly deflection	beyond the edge of backlight $\leq 0.2\text{mm}$								
		Bulge (undulation included)	The ITO film plumped below 0.40mm, it's ok. 								
		Newton Ring	Newton Ring area $> 1/3$ TP area NG Newton Ring area $\leq 1/3$ TP area OK								
		TP corner broken X : length Y : width Z : height	<table border="1" data-bbox="699 1487 1139 1680"> <thead> <tr> <th>X</th> <th>Y</th> <th>Z</th> </tr> </thead> <tbody> <tr> <td>$X \leq 3\text{mm}$</td> <td>$Y \leq 3\text{mm}$</td> <td>$Z < \text{COVER thickness}$ s</td> </tr> </tbody> </table> <p>*Circuitry broken is not allowed.</p>		X	Y	Z	$X \leq 3\text{mm}$	$Y \leq 3\text{mm}$	$Z < \text{COVER thickness}$ s	
X	Y	Z									
$X \leq 3\text{mm}$	$Y \leq 3\text{mm}$	$Z < \text{COVER thickness}$ s									

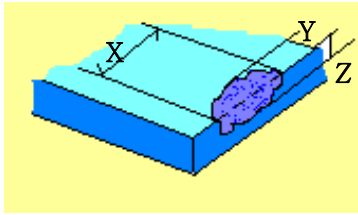
		TP edge broken X : length Y : width Z : height	X	Y	Z	
			X≤4mm	Y≤2mm	Z<COVER thickness	
			* Circuitry broken is not allowed.			

Criteria (functional items)

Number	Items	Criteria (mm)
1	No display	Not allowed
2	Missing segment	Not allowed
3	Short	Not allowed
4	Backlight no lighting	Not allowed
5	TP no function	Not allowed

9. Reliability Test Result

Item	Condition	Inspection after test
High Temperature Operating	70°C,96H	Inspection after 2~4hours storage at room temperature, the sample shall be free from defects: 1.Air bubble in the LCD; 2.Non-display; 3.Missing segments/line; 4.Glass crack; 5.Current IDD is twice higher than initial value.
Low Temperature Operating	-20 °C, 96HR	
High Temperature Storage	80 °C, 96HR	
Low Temperature Storage	-30 °C, 96HR	
High Temperature & High Operating	+60 °C, 90% RH ,96 hours.	
Thermal Shock (Non-operation)	-30 °C,30 min ↔ 80 °C,30 min, Change time:5min 20CYC.	
ESD test	C=150pF, R=330,5points/panel Air:±8KV, 5times; Contact:±6KV, 5 times; (Environment: 15°C~35°C, 30%~60%).	
Vibration (Non-operation)	Frequency range:10~55Hz, Stroke:1.5mm Sweep:10Hz~55Hz~10Hz 2 hours for each direction of X.Y.Z. (6 hours for total) (Package condition).	
Box Drop Test	1 Corner 3 Edges 6 faces,80cm(MEDIUM BOX)	

Remark:

- The test samples should be applied to only one test item.
- Sample size for each test item is 5~10pcs.
- For Damp Proof Test, Pure water(Resistance > 10MΩ) should be used.
- In case of malfunction defect caused by ESD damage, if it would be recovered to normal state after resetting, it would be judged as a good part.
- Failure Judgment Criterion: Basic Specification, Electrical Characteristic, Mechanical Characteristic, Optical Characteristic.

Part. No	KD070HDFIA018-RT	REV	V1.0	Page 28 of 30
	常备库存 Stock For Sale	长期供货 Long Time supply	支持小量 NO MOQ	品种齐全 In Full Range

10. Cautions and Handling Precautions

10.1 Handling and Operating the Module

(1) When the module is assembled, it should be attached to the system firmly.

Do not warp or twist the module during assembly work.

(2) Protect the module from physical shock or any force. In addition to damage, this may cause improper operation or damage to the module and back-light unit.

(3) Note that polarizer is very fragile and could be easily damaged. Do not press or scratch the surface.

(4) Do not allow drops of water or chemicals to remain on the display surface.

If you have the droplets for a long time, staining and discoloration may occur.

(5) If the surface of the polarizer is dirty, clean it using some absorbent cotton or soft cloth.

(6) The desirable cleaners are water, IPA (Isopropyl Alcohol) or Hexane.

Do not use ketene type materials (ex. Acetone), Ethyl alcohol, Toluene, Ethyl acid or Methyl chloride. It might permanent damage to the polarizer due to chemical reaction.

(7) If the liquid crystal material leaks from the panel, it should be kept away from the eyes or mouth. In case of contact with hands, legs, or clothes, it must be washed away thoroughly with soap.

(8) Protect the module from static; it may cause damage to the CMOS ICs.

(9) Use finger-stalls with soft gloves in order to keep display clean during the incoming inspection and assembly process.

(10) Do not disassemble the module.

(11) Protection film for polarizer on the module shall be slowly peeled off just before use so that the electrostatic charge can be minimized.

(12) Pins of I/F connector shall not be touched directly with bare hands.

(13) Do not connect, disconnect the module in the "Power ON" condition.

(14) Power supply should always be turned on/off by the item 6.1 Power On Sequence & 6.2 Power Off Sequence

10.2 Storage and Transportation.

(1) Do not leave the panel in high temperature, and high humidity for a long time.

It is highly recommended to store the module with temperature from 0 to 35 °C and relative humidity of less than 70%

(2) Do not store the TFT-LCD module in direct sunlight.

(3) The module shall be stored in a dark place. When storing the modules for a long time, be sure to adopt effective measures for protecting the modules from strong ultraviolet radiation, sunlight, or fluorescent light.

(4) It is recommended that the modules should be stored under a condition where no condensation is allowed. Formation of dewdrops may cause an abnormal operation or a failure of the module.

In particular, the greatest possible care should be taken to prevent any module from being operated where condensation has occurred inside.

(5) This panel has its circuitry FPC on the bottom side and should be handled carefully in order not to be stressed.

Part. No	KD070HDFIA018-RT	REV	V1.0	Page 29 of 30
	常备库存 Stock For Sale	长期供货 Long Time supply	支持小量 NO MOQ	品种齐全 In Full Range

11. Packing

---TBD-----

Part. No	KD070HDFIA018-RT	REV	V1.0	Page 30 of 30
	常备库存 Stock For Sale	长期供货 Long Time supply	支持小量 NO MOQ	品种齐全 In Full Range